

SERPAC CIRCUIT BOARD C28

Electronic Enclosures

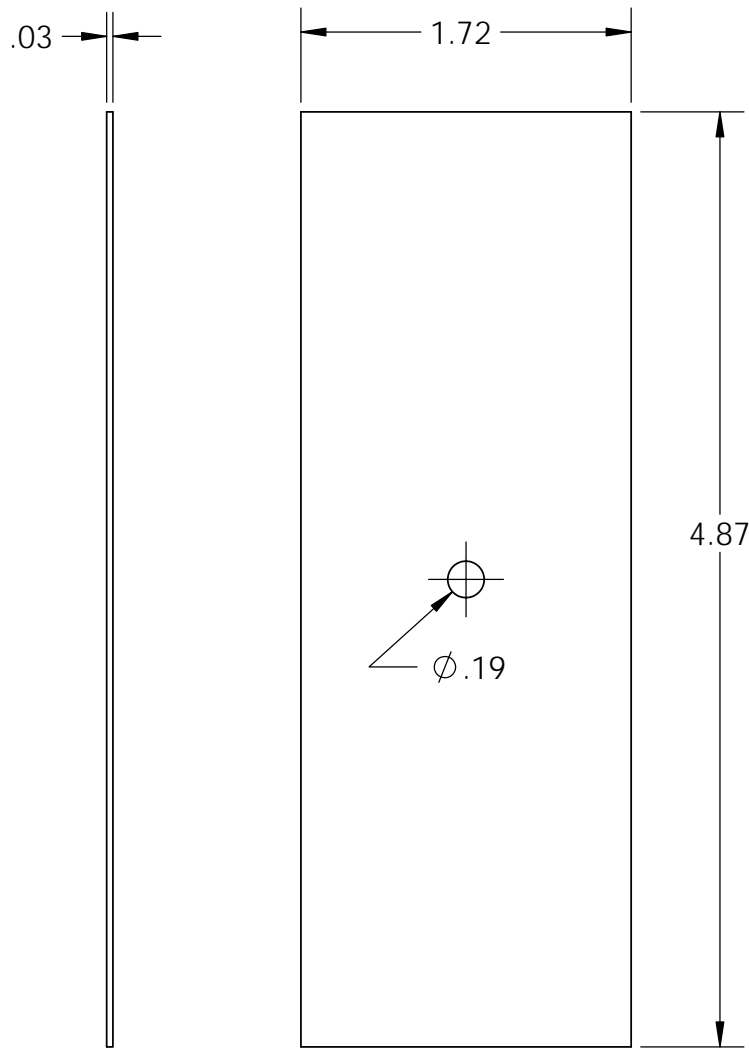

.032 board

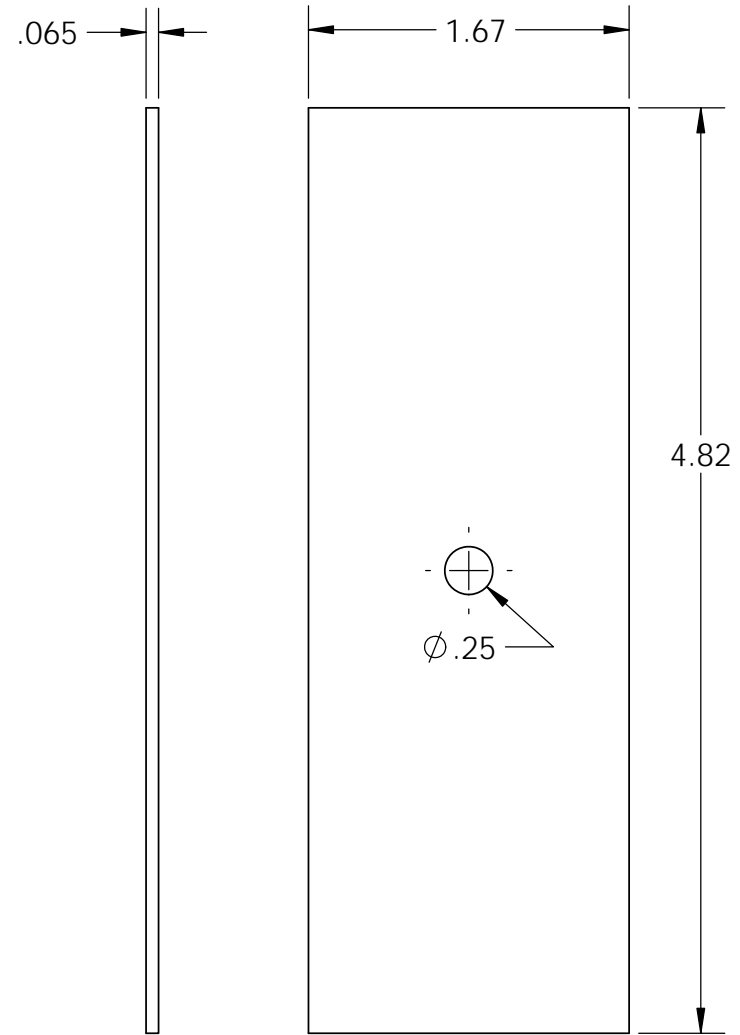

.065 board

NOTES:
These are suggested dimensions.
Plastic parts have a ± 0.010 " manufacturing tolerance.