

SE335

SEAHORSE PROTECTIVE EQUIPMENT CASES

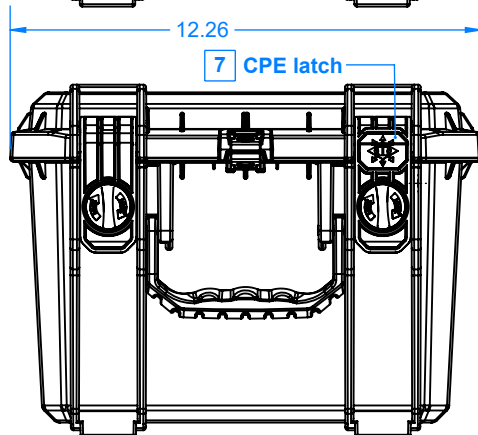

5 SE335PL
plastic lock

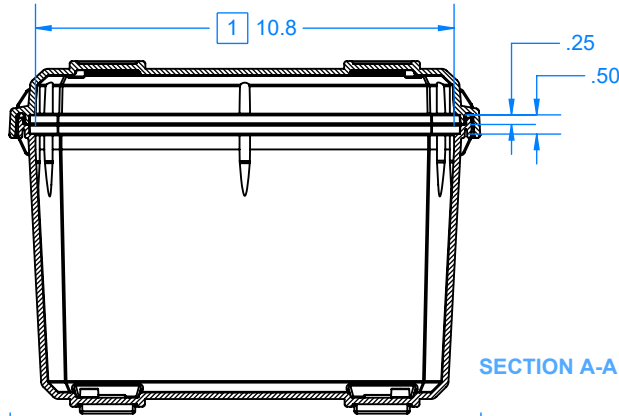
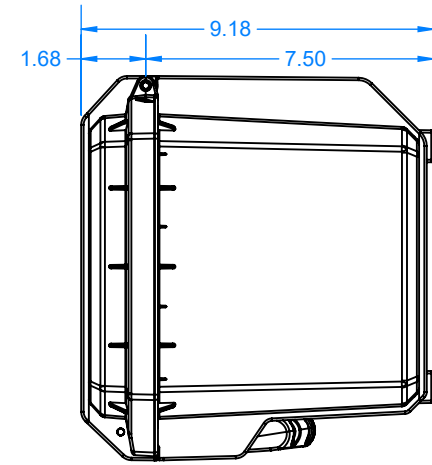
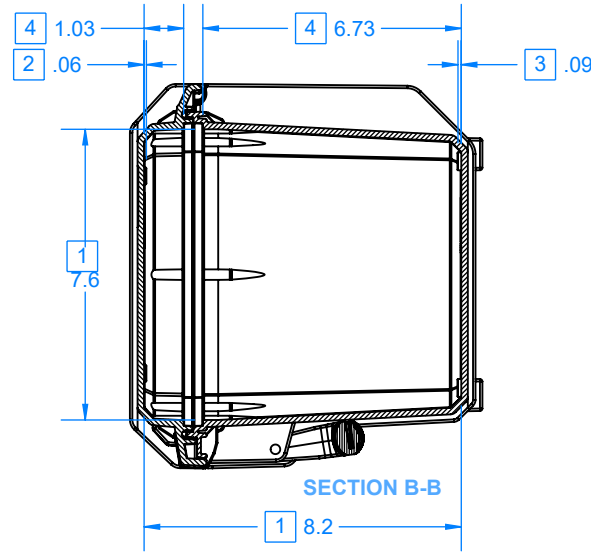
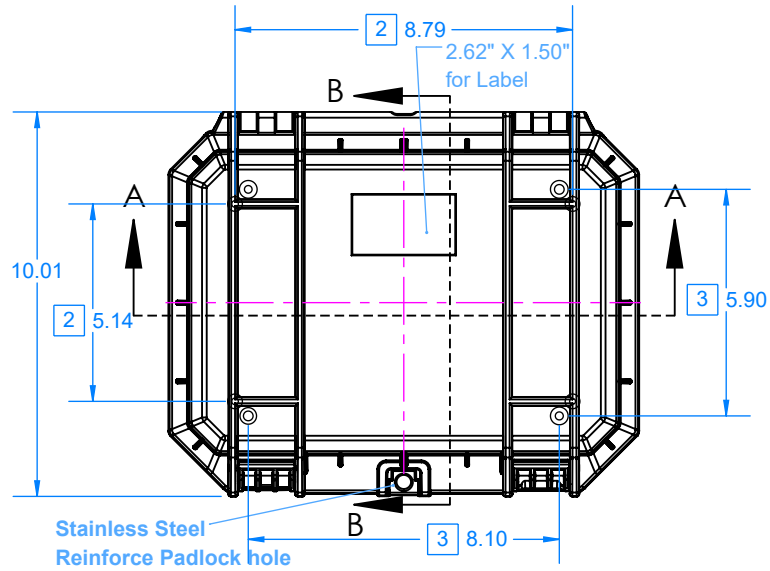
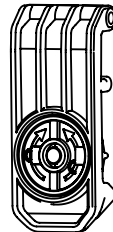

5 SE335ML
metal lock

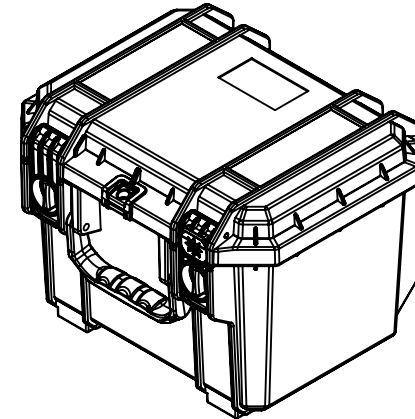
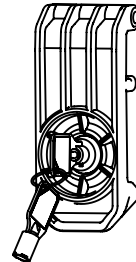

NOTES:

- 1) Max. usable inside dimensions are:
10.8" X 7.6" X 8.2"
- 2) Bosses on Top use a #10 self tapping screw.
- 3) Bosses on bottom use a #10 self tapping screw.
- 4) Dimensions to bottom of panel flange.
- 5) Optional latches specify:
SE335ML with Metal Lock.
SE335PL with Plastic Lock.
- 6) Weight empty/w-foam: 3.5/4.01 lb.
Buoyancy: 20 lb.
Weight capacity: 45 lb.
- 7) CPE = Continues Pressure Equalization latch.

SE335 Panel

SEAHORSE
PROTECTIVE EQUIPMENT CASES

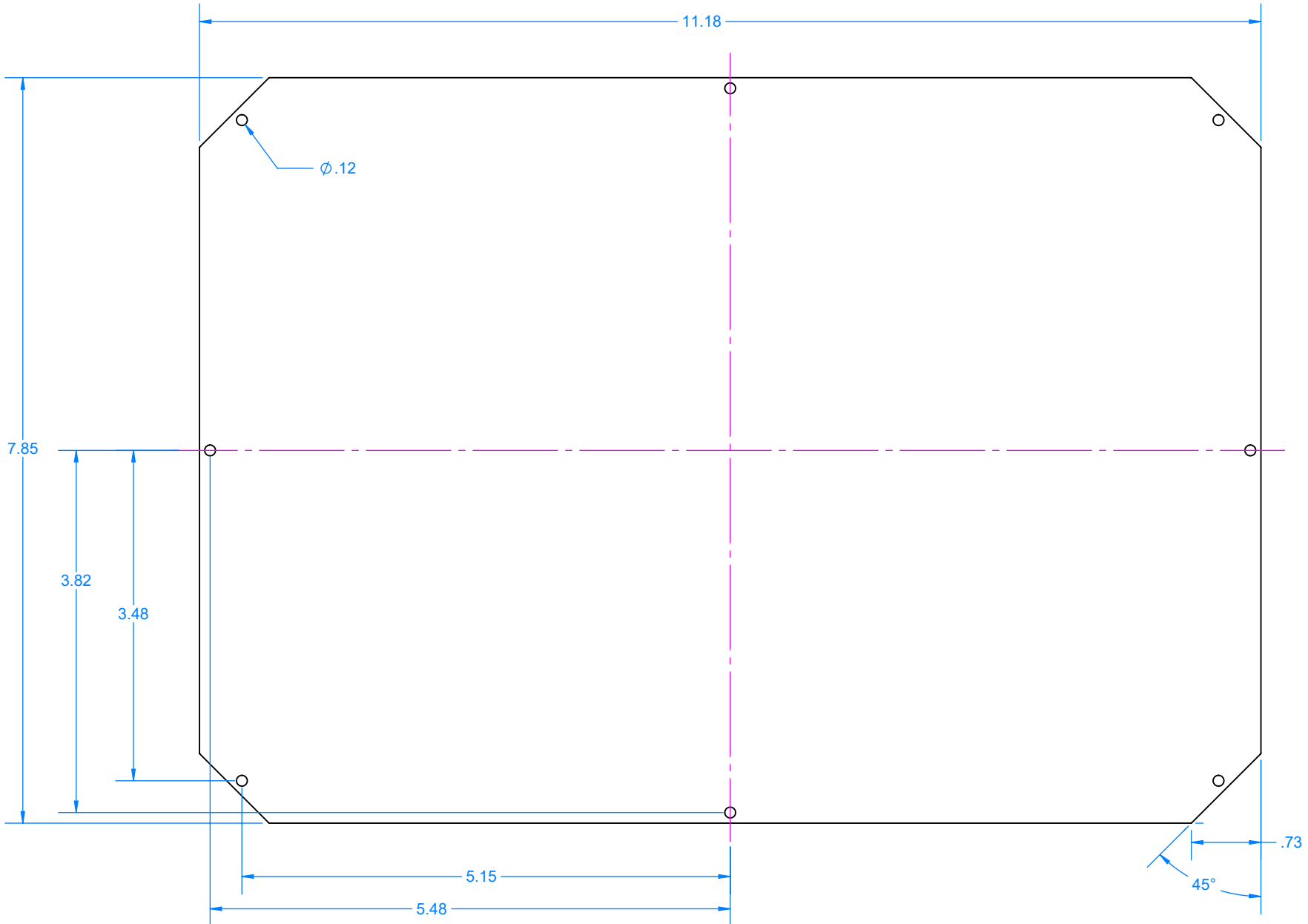

Top Panel for SE335

SEAHORSE
PROTECTIVE EQUIPMENT CASES

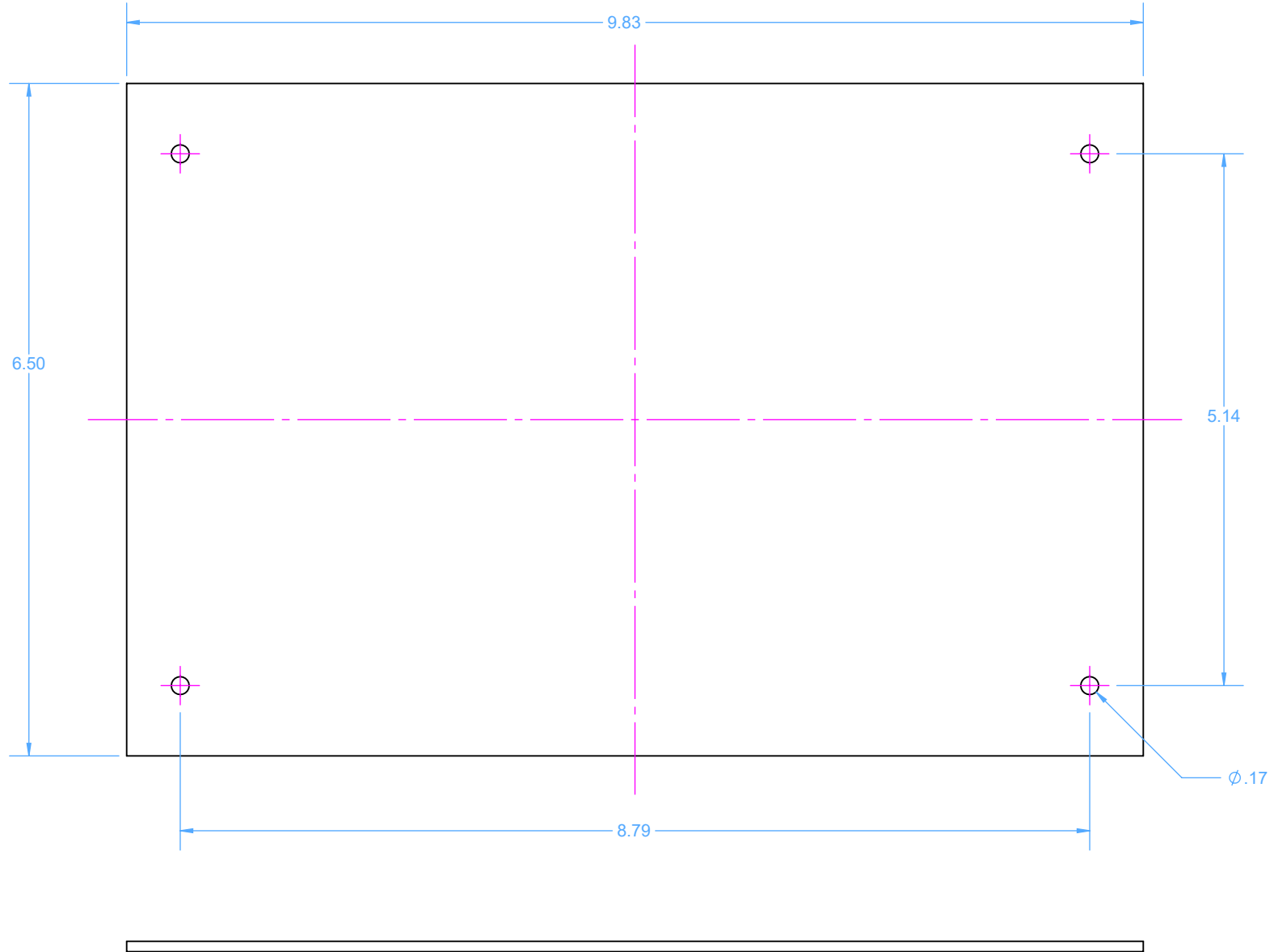

Bottom Panel for SE335

SEAHORSE
PROTECTIVE EQUIPMENT CASES

