

SERPAC RB66X06Y28Y 2

Electronic Enclosures

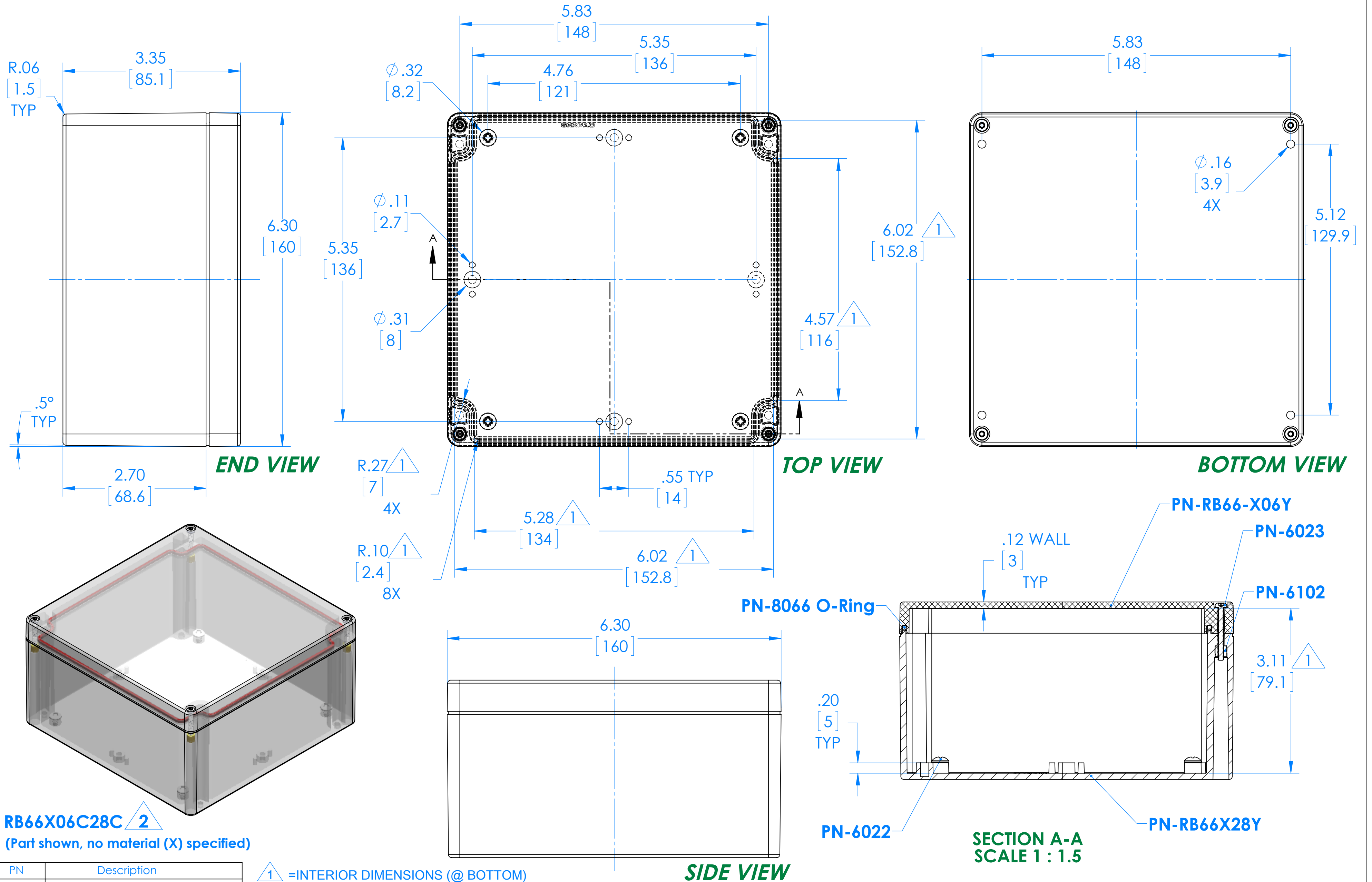

RB66X06C28C 2
(Part shown, no material (X) specified)

PN	Description
RB66-X06Y	(1) RB66-X06Y Top
RB66X28Y	(1) RB66X28Y Bottom
8066	(1) RB66 O-Ring
6023	(4) #4-40 Torx 10 Hd Screw
6022	(4) #10 High/Low Pan Hd x 1/4"
6102	(4) #4-40 Threaded Insert

1 =INTERIOR DIMENSIONS (@ BOTTOM)

2 =STANDARD COLORS (Y) ARE: BLACK (B), CLEAR (C) AND GRAY (G)
TOPS AND BOTTOMS ALL POSSIBLE COMBINATIONS AVAILABLE
STANDARD MATERIALS (X) ARE: POLYCARBONATE (P) AND ABS (A)

-Watertight enclosure meets or exceed Nema 4 and or IP67.

DIMENSIONS in Inch [mm]